



# ***Blue Sky Scaffold, LLC***

***Sales · Rentals · Solutions***

## **Product Catalogue**

Product Identification  
Ringscaff Components

# Blue Sky Scaffold LLC.



**BLUE SKY SCAFFOLD IS YOUR ONE STOP SHOP FOR ALL YOUR SCAFFOLDING MATERIAL NEEDS. WE HAVE A FULLY STOCKED YARD LOCATED IN CHESAPEAKE VA. WE ALSO HAVE A YARD IN MOBILE AL, AND FL. BLUE SKY IS A FULL-SERVICE SCAFFOLDING PROVIDER. WE HAVE EQUIPMENT FOR RENT AND SALE. FEEL FREE TO CONTACT US AT [Sales@Blueskyscaffold.com](mailto:Sales@Blueskyscaffold.com).**

# Base Components

Item Code	Description	Weight
BBC101	Base/Starter Collar	5
BBJ102	Screw jack/Base Jack	8
BSJ103	Swivel Jack	12
BCW101	Caster 12"	34
BCA101	Adaptor for Caster	9
BCW102	Caster 8"	13
BAS105	Screw jack/Base Jack 1.5'	6
BUJ104	U Head Base Jack	8
BWM102	Wood Mud Sill	2



Base Starter collar



Screw jack/ Base jack



Swivel jack



Adapter for caster



8" Caster



Screw jack/Base jack 1.5'



12" Caster



U head jack



# Standards

Item Code	Description	Length	Weight
STH101	Std 0.5m/1'8" 1 Ring w/Spigot	1'8"	7
STH102	Std 1.0m/3'3" 2 Ring w/Spigot	3'3"	13
STH103	Std 1.5m/4'11" 3 Ring w/Spigot	4'11"	18
STH104	Std 2.0m/6'6" 4 Ring w/Spigot	6'6"	23
STH105	Std 2.5m/8'2" 5 Ring w/Spigot	8'2"	29
STH106	Std 3.0m/9'9" 6 Ring w/Spigot	9'9"	34
STH107	Std 4.0m/13'1" 8 Ring w/Spigot	13'1"	44
STH201	Std Guardrail 2 Ring Crazy Leg	4'0"	18

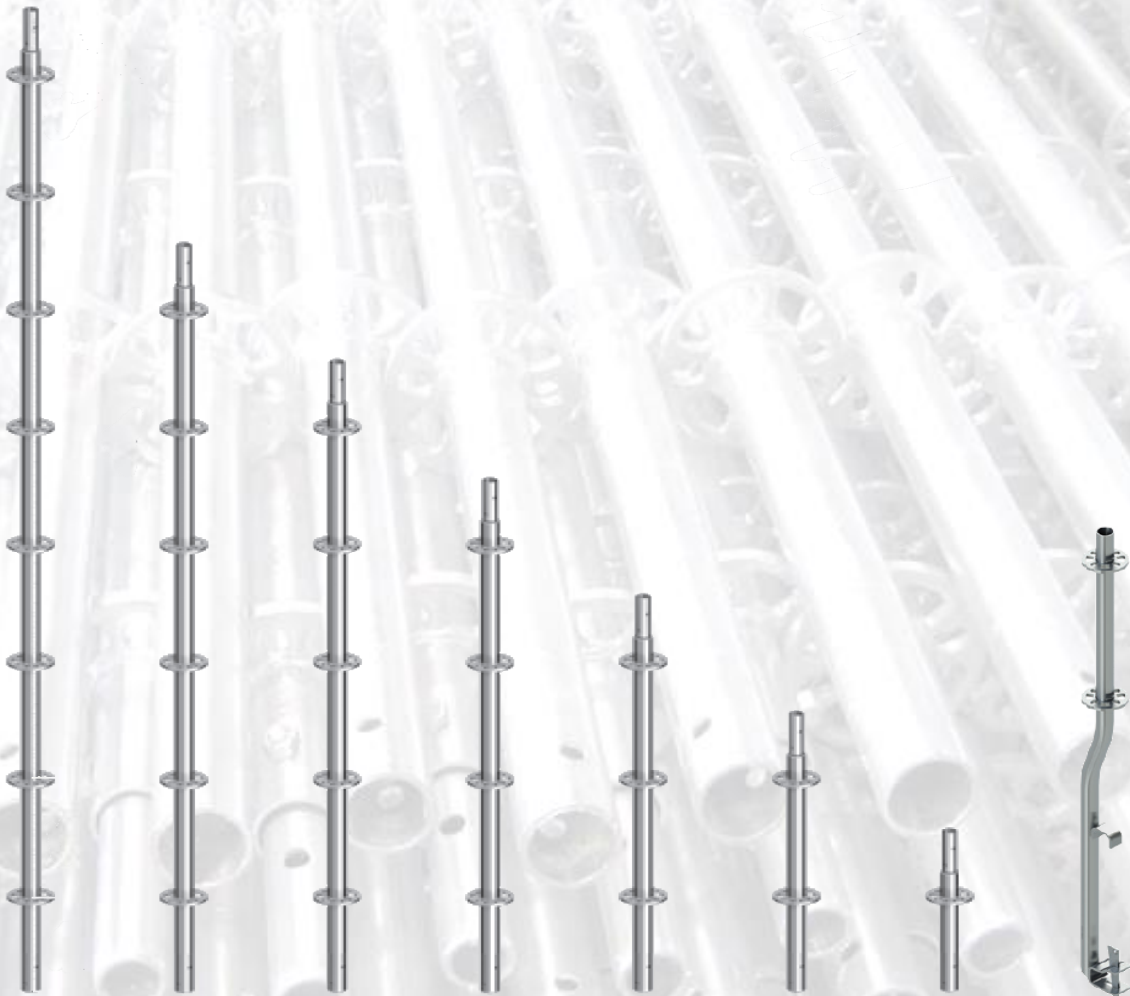

# Ledgers

Item Code	Description	Length	Weight
LED101	Ledger O-Type 0.30m/1'0"	1'0"	4
LED102	Ledger O-Type 0.38m/1'3"	1'3"	5
LED103	Ledger O-Type 0.58m/1'11"	1'11"	7
LED104	Ledger O-Type 0.61m/2'0"	2'0"	7
LED105	Ledger O-Type 0.66m/2'2"	2'2"	7
LED106	Ledger O-Type 0.74m/2'5"	2'5"	8
LED107	Ledger O-Type 0.76m/2'6"	2'6"	8
LED108	Ledger O-Type 0.83m/2' 8-5/8"	2'8-5/8"	9
LED109	Ledger O-Type 0.84m/2'9"	2'9"	9
LED110	Ledger O-Type 0.88m/2'10-5/8"	2'10-5/8"	-
LED111	Ledger O-Type 0.91m/3'	3'0"	9
LED112	Ledger O-Type 1.067m/3'6"	3'6"	11
LED113	Ledger O-Type 1.083m/3'6-5/8"	3'6-5/8"	10.42
LED114	Ledger O-Type 1.09m/3'7"	3'7"	11
LED115	Ledger O-Type 1.17m/3'10"	3'10"	11
LED116	Ledger O-Type 1.22m/4'	4'0"	12
LED117	Ledger O-Type 1.40m/4'7"	4'7"	13
LED118	Ledger O-Type 1.52m/5'	5'0"	14
LED119	Ledger O-Type 1.57m/5'2"	5'2"	15
LED120	Ledger O-Type 1.83m/6'	6'0"	17
LED121	Ledger O-Type 2.07m/6'10"	6'10"	19
LED122	Ledger O-Type 2.13m/7'	7'0"	19
LED123	Ledger O-Type 2.39m/7'10"	7'10"	21
LED124	Ledger O-Type 2.44m/8'	8'0"	22
LED125	Ledger O-Type 2.57m/8'5"	8'5"	23
LED126	Ledger O-Type 3.05m/10'	10'0"	27



# Bay Braces

Item Code	Description	Length	Weight
BRC101	Bay Brace 0.30m/1'0"	1'0"	17
BRC102	Bay Brace 0.38m/1'3"	1'3"	17
BRC103	Bay Brace 0.58m/1'11"	1'11"	18
BRC104	Bay Brace 0.61m/2'0"	2'0"	18
BRC105	Bay Brace 0.66m/2'2"	2'2"	18
BRC106	Bay Brace 0.74m/2'5"	2'5"	18
BRC107	Bay Brace 0.76m/2'6"	2'6"	18
BRC108	Bay Brace 0.83m/2' 8-5/8"	2'8-5/8"	18
BRC109	Bay Brace 0.84m/2'9"	2'9"	18
BRC111	Bay Brace 0.91m/3'	3'0"	18
BRC112	Bay Brace 1.067m/3'6"	3'6"	19
BRC113	Bay Brace 1.066m/3'6-5/8"	3'6-5/8"	19
BRC114	Bay Brace 1.09m/3'7"	3'7"	19
BRC115	Bay Brace 1.17m/3'10"	3'10"	19
BRC116	Bay Brace 1.22m/4'	4'0"	19
BRC117	Bay Brace 1.40m/4'7"	4'7"	20
BRC118	Bay Brace 1.52m/5'	5'0"	20
BRC119	Bay Brace 1.57m/5'2"	5'2"	20
BRC120	Bay Brace 1.83m/6'	6'0"	21
BRC121	Bay Brace 2.08m/6'10"	6'10"	22
BRC222	Bay Brace 2.13m/7' X 1.5M	7' X 1.5M	22
BRC122	Bay Brace 2.13m/7' X 2M	7' X 2M	23
BRC123	Bay Brace 2.39m/7'10"	7'10"	24
BRC124	Bay Brace 2.44m/8'	8'0"	24
BRC125	Bay Brace 2.57m/8'5"	8'5"	25
BRC126	Bay Brace 3.05m/10'	10'0"	27

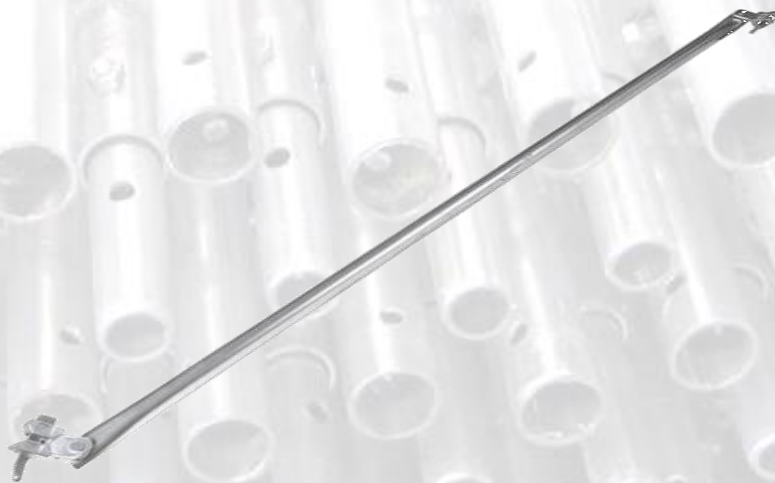



# Advanced Handrails

Item Code	Description	Length	Weight
HRL107	Handrail 2 Ring 0.76m/2'6"	2'6"	11
HRL109	Handrail 2 Ring 0.84m/2'9"	2'9"	12
HRL112	Handrail 2 Ring 1.067m/3'6"	3'6"	15
HRL115	Handrail 2 Ring 1.17m/3'10"	3'10"	15
HRL117	Handrail 2 Ring 1.40m/4'7"	4'7"	18
HRL118	Handrail 2 Ring 1.52m/5'	5'0"	19
HRL120	Handrail 2 Ring 1.83m/6'	6'0"	26
HRL122	Handrail 2 Ring 2.13m/7'	7'0"	28
HRL124	Handrail 2 Ring 2.44m/8'	8'0"	30
HRL126	Handrail 2 Ring 3.05m/10'	10'0"	37
HRL217	Handrail 3 Ring 1.40m/4'7"	4'7"	22
HRL212	Handrail 3 Ring 1.067m/3'6"	3'6"	16
HRL218	Handrail 3 Ring 1.52m/5'	5'0"	24
HRL220	Handrail 3 Ring 1.83m/6'	6'0"	27
HRL222	Handrail 3 Ring 2.13m/7'	7'0"	38
HRL224	Handrail 3 Ring 2.44m/8'	8'0"	42
HRL226	Handrail 3 Ring 3.05m/10'	10'0"	44



# Double Ledgers

Item Code	Description	Length	Weight
DLD118	Double Ledger 1.52m/5' D	5'	23
DLD119	Double Ledger 1.57m/5'2" D	5'2"	23
DLD120	Double Ledger 1.83m/6' D	6'	28
DLD121	Double Ledger 2.08m/6'10" D	6'10"	31
DLD122	Double Ledger 2.13m/7' D	7'	32
DLD123	Double Ledger 2.40m/7'10" D	7'10"	37
DLD124	Double Ledger 2.44m/8' D	8'	37
DLD125	Double Ledger 2.57m/8'5" D	8'5"	39
DLD126	Double Ledger 3.05m/10' D	10'	46
BLD101	Truss Ledger 1.52m/5' T	5'	23
BLD102	Truss Ledger 1.57m/5'2" T	5'2"	23
BLD103	Truss Ledger 1.83m/6' T	6'	28
BLD104	Truss Ledger 2.08m/6'10" T	6'10"	31
BLD105	Truss Ledger 2.13m/7' T	7'	32
BLD106	Truss Ledger 2.40m/7'10" T	7'10"	37
BLD107	Truss Ledger 2.44m/8' T	8'	37
BLD108	Truss Ledger 2.57m/8'5" T	8'5"	39
BLD109	Truss Ledger 3.05m/10' T	10'	46



Double Ledger



Truss Ledger



# Side Brackets

Item Code	Description	Length	Weight
SBK101	Side Bracket 0.31m/1'	1'	5
SBK102	Side Bracket 0.38m/1'3"	1'3"	11
SBK104	Side Bracket 0.61m/2'	2'	13
SBK105	Side Bracket 0.66m/2'2"	2'2"	15
SBK106	Side Bracket 0.74m/2'5"	2'5"	16
SBK109	Side Bracket 0.84m/2'9"	2'9"	19
SBK110	Side Bracket 0.88M/2'10-5/8"	8"	10
SBK112	Side Bracket 1.067m/3'6"	3'6"	12
SBK115	Side Bracket 1.15m/3'10"	3'10"	15
SBK202	2 Board Bracket (240mm)	240mm	13
SBK203	3 Board Bracket (240mm)	240mm	13
SBK301	Extendable Side Bracket 1 BRD +1/2	2	13
SBK302	Extendable Side Bracket 2 BRD +1	1	13



Side Bracket/Outrigger



Console Style Bracket/Knee out

# 12" Planks

Item Code	Description	Length	Weight
LPL101	LAY 12" Plank 0.30m/1'0"	1'0"	12
LPL102	LAY 12" Plank 0.38m/1'3"	1'3"	12
LPL103	LAY 12" Plank 0.58m/1'11"	1'11"	16
LPL104	LAY 12" Plank 0.61m/2'0"	2'0"	16
LPL105	LAY 12" Plank 0.66m/2'2"	2'2"	16
LPL106	LAY 12" Plank 0.74m/2'5"	2'5"	18
LPL107	LAY 12" Plank 0.76m/2'6"	2'6"	18
LPL108	LAY 12" Plank 0.83m/2'8-5/8"	8"	19
LPL109	LAY 12" Plank 0.84m/2'9"	2'9"	20
LPL111	LAY 12" Plank 0.91m/3'	3'	21
LPL112	LAY 12" Plank 1.067m/3'6"	3'6"	23
LPL113	LAY 12" Plank 1.083m/3'6-5/8"	8"	23
LPL114	LAY 12" Plank 1.09m/3'7"	3'7"	24
LPL115	LAY 12" Plank 1.17m/3'10"	3'10"	25
LPL116	LAY 12" Plank 1.22m/4'	4'	26
LPL117	LAY 12" Plank 1.40m/4'7"	4'7"	29
LPL118	LAY 12" Plank 1.52m/5'	5'	31
LPL119	LAY 12" Plank 1.57m/5'2"	5'2"	32
LPL120	LAY 12" Plank 1.83m/6'	6'	36
LPL121	LAY 12" Plank 2.07m/6'10"	6'10"	40
LPL122	LAY 12" Plank 2.13m/7'	7'	41
LPL123	LAY 12" Plank 2.39m/7'10"	7'10"	46
LPL124	LAY 12" Plank 2.44m/8'	8'	46
LPL125	LAY 12" Plank 2.57m/8'5"	8'5"	49
LPL126	LAY 12" Plank 3.05m/10'	10'	57

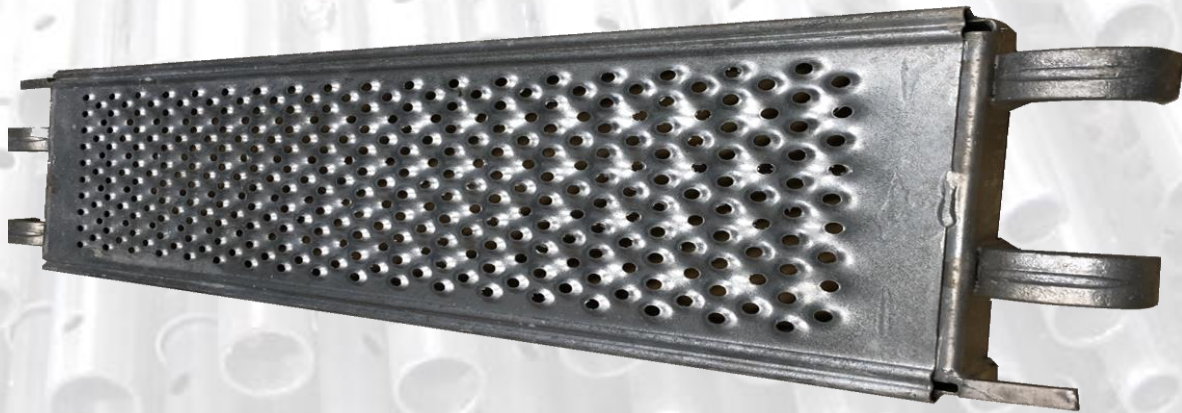



# Canadian Plank

Item Code	Description	Length	Weight
CPL101	Canadian Plank 0.30m/1'0"	1'0"	8
CPL102	Canadian Plank 0.38m/1'3"	1'3"	10
CPL103	Canadian Plank 0.58m/1'11"	1'11"	13
CPL104	Canadian Plank 0.61m/2'0"	2'0"	13
CPL105	Canadian Plank 0.66m/2'2"	2'2"	13
CPL106	Canadian Plank 0.74m/2'5"	2'5"	14
CPL107	Canadian Plank 0.76m/2'6"	2'6"	15
CPL108	Canadian Plank 0.83m/2' 8-5/8"	2'8-5/8"	16
CPL109	Canadian Plank 0.84m/2'9"	2'9"	16
CPL110	Canadian Plank 0.88m/2'10-5/8"	2'10"	17
CPL111	Canadian Plank 0.91m/3'	3'0"	17
CPL112	Canadian Plank 1.067m/3'6"	3'6"	19
CPL113	Canadian Plank 1.083m/3'6-5/8"	3'6-5/8"	19
CPL114	Canadian Plank 1.09m/3'7"	3'7"	19
CPL115	Canadian Plank 1.17m/3'10"	3'10"	19
CPL116	Canadian Plank 1.22m/4'	4'0"	21
CPL117	Canadian Plank 1.40m/4'7"	4'7"	23
CPL118	Canadian Plank 1.52m/5'	5'0"	25
CPL119	Canadian Plank 1.57m/5'2"	5'2"	26
CPL120	Canadian Plank 1.83m/6'	6'0"	29
CPL121	Canadian Plank 2.07m/6'10"	6'10"	32
CPL122	Canadian Plank 2.13m/7'	7'0"	33
CPL123	Canadian Plank 2.39m/7'10"	7'10"	37
CPL124	Canadian Plank 2.44m/8'	8'0"	37
CPL125	Canadian Plank 2.57m/8'5"	8'5"	37
CPL126	Canadian Plank 3.05m/10'	10'0"	45





# Raised Hook Plank

Item Code	Description	Length	Weight
RHP101	Raised Hook Plank 0.30m/1'0"	1'0"	8
RHP102	Raised Hook Plank 0.38m/1'3"	1'3"	10
RHP103	Raised Hook Plank 0.58m/1'11"	1'11"	13
RHP104	Raised Hook Plank 0.61m/2'0"	2'0"	13
RHP105	Raised Hook Plank 0.66m/2'2"	2'2"	13
RHP106	Raised Hook Plank 0.74m/2'5"	2'5"	14
RHP107	Raised Hook Plank 0.76m/2'6"	2'6"	15
RHP108	Raised Hook Plank 0.83m/2' 8-5/8"	2'8-5/8"	16
RHP109	Raised Hook Plank 0.84m/2'9"	2'9"	16
RHP111	Raised Hook Plank 0.91m/3'	3'0"	17
RHP112	Raised Hook Plank 1.067m/3'6"	3'6"	17
RHP113	Raised Hook Plank 1.083m/3'6-5/8"	3'6-5/8"	19
RHP114	Raised Hook Plank 1.09m/3'7"	3'7"	19
RHP115	Raised Hook Plank 1.17m/3'10"	3'10"	19
RHP116	Raised Hook Plank 1.22m/4'	4'0"	19
RHP117	Raised Hook Plank 1.40m/4'7"	4'7"	21
RHP118	Raised Hook Plank 1.52m/5'	5'0"	23
RHP119	Raised Hook Plank 1.57m/5'2"	5'2"	25
RHP120	Raised Hook Plank 1.83m/6'	6'0"	26
RHP121	Raised Hook Plank 2.07m/6'10"	6'10"	29
RHP122	Raised Hook Plank 2.13m/7'	7'0"	32
RHP123	Raised Hook Plank 2.39m/7'10"	7'10"	33
RHP124	Raised Hook Plank 2.44m/8'	8'0"	37
RHP125	Raised Hook Plank 2.57m/8'5"	8'5"	37
RHP126	Raised Hook Plank 3.05m/10'	10'0"	45



# Toe Boards

Item Code	Description	Length	Weight
TBS103	Toe board 0.58m/1'11"	1'11"	6.5
TBS104	Toe board 0.61m/2'0"	2'0"	7
TBS105	Toe board 0.66m/2'2"	2'2"	7
TBS106	Toe board 0.74m/2'5"	2'5"	7.5
TBS107	Toe board 0.76m/2'6"	2'6"	9
TBS108	Toe board 0.83m/2' 8-5/8"	2'8 5/8"	8
TBS109	Toe board 0.84m/2'9"	2'9"	8.5
TBS111	Toe board 0.91m/3'	3'0"	9
TBS112	Toe board 1.067m/3'6"	3'6"	9.5
TBS114	Toe board 1.09m/3'7"	3'7"	10
TBS115	Toe board 1.17m/3'10"	3'10"	10.5
TBS116	Toe board 1.22m/4'	4'0"	11
TBS117	Toe board 1.40m/4'7"	4'7"	12.5
TBS118	Toe board 1.52m/5'	5'0"	13
TBS119	Toe board 1.57m/5'2"	5'2"	13.5
TBS120	Toe board 1.83m/6'	6'0"	15
TBS121	Toe board 2.07m/6'10"	6'10"	17
TBS122	Toe board 2.13m/7'	7'0"	17.5
TBS123	Toe board 2.39m/7'10"	7'10"	22
TBS124	Toe board 2.43m/8'	8'0"	19.5
TBS125	Toe board 2.57m/8'5"	8'5"	20.5
TBS126	Toe board 3.05m/10'	10'0"	24
TBD203	Toe board 0.58m/1'11" ALT-G	1'11"	2.89
TBD205	Toe board 0.66m/2'2" ALT-G	2'2"	3.12
TBD206	Toe board 0.73m/2'5" ALT-G	2'5"	3.57
TBD208	Toe board 0.83m/2'8-5/8" ALT-G	2'8"	4.11
TBD210	Toe board 0.88m/2'10-5/8" ALT-G	2'10"	4.33
TBD211	Toe board 0.91m/3' ALT-G	3'0"	4.51
TBD212	Toe board 1.067m/3'6" ALT-G	3'6"	4.91
TBD214	Toe board 1.09m/3'7" ALT-G	3'7"	5.42
TBD215	Toe board 1.17m/3'10" ALT-G	3'10"	5.75
TBD216	Toe board 1.21m/4' ALT-G	4'0"	6.11
TBD218	Toe board 1.52m/5' ALT-G	5'0"	7.72
TBD219	Toe board 1.57m/5'2" ALT-G	5'2"	7.96
TBD220	Toe board 1.83m/6' ALT-G	6'0"	9.32
TBD222	Toe board 2.13m/7' ALT-G	7'0"	10.91
TBD224	Toe board 2.44m/8' ALT-G	8'0"	12.53
TBD225	Toe board 2.57m/8'5" ALT-G	8'5"	12.73

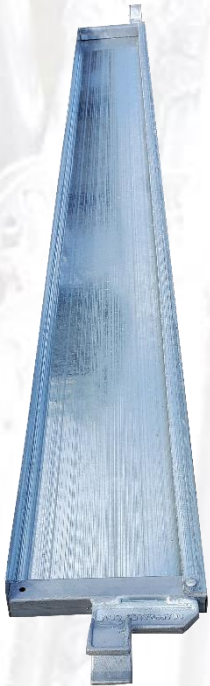

TBD226	Toe board 3.05m/10' ALT-G	10'0"	15.75
TBD230	Toe board 1.3m/4'3" ALT-G	4'3"	6.28
TBD240	Toe board 2.06m/6'9" ALT-G	6'9"	9.98
TBD303	Toe board 0.58m/1'11" ALT-GP	1'11"	2.89
TBD305	Toe board 0.66m/2'2" ALT-GP	2'2"	3.12
TBD308	Toe board 0.83m/2'8-5/8" ALT-GP	2'8"	4.11
TBD310	Toe board 0.88m/2'10-5/8" ALT-GP	2'10"	4.33
TBD311	Toe board 0.91m/3' ALT-GP	3'0"	4.51
TBD312	Toe board 1.067m/3'6" ALT-GP	3'6"	4.91
TBD314	Toe board 1.09m/3'7" ALT-GP	3'7"	5.42
TBD315	Toe board 1.17m/3'10" ALT-GP	3'10"	5.75
TBD316	Toe board 1.21m/4' ALT-GP	4'0"	6.11
TBD318	Toe board 1.52m/5' ALT-GP	5'0"	7.72
TBD319	Toe board 1.57m/5'2" ALT-GP	5'2"	7.96
TBD320	Toe board 1.83m/6' ALT-GP	6'0"	9.32
TBD322	Toe board 2.13m/7' ALT-GP	7'0"	10.91
TBD324	Toe board 2.44m/8' ALT-GP	8'0"	12.53
TBD325	Toe board 2.57m/8'5" ALT-GP	8'5"	12.73
TBD326	Toe board 3.05m/10' ALT-GP	10'0"	15.75



# Stair Access

Item Code	Description	Weight
ASC104	7'X3.5'X2M Alum Staircase	99
ASC103	7'X3.5'X1.5M Alum Staircase	92
ASC102	7'X3.5'X1M Alum Staircase	95
SCT122	7' Staircase Transom	29
ALS104	10'X2M Landing Staircase	108
LSE104	10'X2M L-Staircase Ext Rail	43
LSI104	10'X2M L-Staircase Int Rail	90
LTI104	10'X2M L-Staircase Top Rail	37.08
ALS103	10'X1.5M Landing Staircase	108
LSE103	10'X 1.5M L-Staircase Ext Rail	41
LSI103	10'X1.5M L-Staircase Int Rail	-
LTI103	10'X1.5M L-Staircase Top Rail	36.82
NTS122	9-Tread Staircase w/Handrails	
SSS122	Stair Stringer 7'x2M L/R	36
SST101	Stair Tread 3'6" Bay	18.5



Landing Staircase



10'x2m Ext Rail

10'x2m Int Rail



7'3.5'x1m Staircase



Stair Stringer 7'x2m L/R



Stair Tread 3'6" Bay

# Steel Ladders

Item Code	Description	Weight
SLR104	2m Ladder	70
SLR106	3m Ladder	105
SLR108	4m Ladder	140
SLR110	5m Ladder	175
SLR112	6m Ladder	171.45
SLR114	8m Ladder	228.6
SLR111	Steel Ladder 3' / 0.91m	14.74
SLR118	Steel Ladder 5' / 1.52m	22.56
SLB101	Steel Ladder Bracket 17"	10.97
ASG101	Adjustable Swing Gate	39.6



17" Ladder Bracket





# Containment Systems

Item Code	Description	Length	Weight
ACP102	Containment Panel .038/1'3"	1'3"	-
ACP103	Containment Panel 0.58m/1'11"	1'11"	15
ACP104	Containment Panel 0.61m/2'0"	2'0"	15
ACP105	Containment Panel 0.66m/2'2"	2'2"	16
ACP106	Containment Panel 0.74m/2'5"	2'5"	17
ACP107	Containment Panel 0.76m/2'6"	2'6"	18
ACP108	Containment Panel .83m/2'8-5/8"	2'8 -5/8"	20
ACP109	Containment Panel 0.88m/2'9"	2'9"	21
ACP111	Containment Panel 0.91m/3'	3'0"	21
ACP112	Containment Panel 1.067m/3'6"	3'6"	24
ACP114	Containment Panel 1.09m/3'7"	3'7"	25
ACP115	Containment Panel 1.17m/3'10"	3'10"	26
ACP116	Containment Panel 1.21m/4'	4'0"	27
ACP117	Containment Panel 1.40m/4'7"	4'7"	31
ACP118	Containment Panel 1.52m/5'	5'0"	34
ACP119	Containment Panel 1.57m/5'2"	5'2"	35
ACP120	Containment Panel 1.83m/6'	6'0"	40
ACP121	Containment Panel 2.07m/6'10"	6'10"	45
ACP122	Containment Panel 2.13m/7'	7'0"	46
ACP123	Containment Panel 2.39m/7'10"	7'10"	51
ACP124	Containment Panel 2.44m/8'	8'0"	52
ACP125	Containment Panel 2.57m/8'5"	8'5"	55
ACP126	Containment Panel 3.05m/10'	10'0"	65
ACC102	Containment Panel Corner	-	-
APP113	Access Pro Panel 7' 2-Ring	7'0"	39
APP114	Access Pro Panel 7' 3-Ring	7'0"	62
APP105	Access Pro Panel 3'6" 2-Ring	3'6"	19
APP106	Access Pro Panel 3'6" 3-Ring	3'6"	35
APP201	Access Pro Corner 2-Ring	-	5
APP202	Access Pro Corner 3-Ring	-	8
APP122	Access Pro Gate 7'	7'0"	139
APB301	Access Pro Base Plate	-	6.74
PBK101	Panel Bracket	-	-



# Fittings



Right angle Clamp

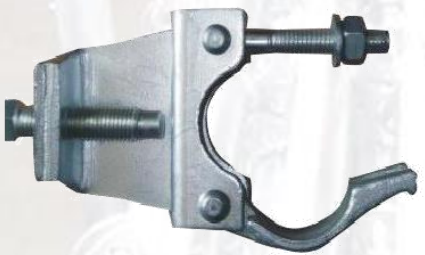

Girder/Beam Clamp



Back-to-Back Wedge Coupler



Wedge Right angle



Spigot Clamp



Mullen Clamp



Swivel Clamp



Swivel Girder/Beam Clamp



Clamp on Ring



Wedge Swivel

Item Code	Description	Weight
FIT101	Right Angle Clamp	4
FIT102	Swivel Clamp	4
FIT103	Girder/Beam Clamp	3
FIT104	Swivel Girder/Beam Clamp	3
FIT105	Spigot Clamp	3
FIT106	Back-to-Back Wedge Coupler	2
FIT107	Removeable Ring	2
FIT108	Wedge Double	3
FIT109	Wedge Swivel	3
FIT110	Single Clamp	-
FIT111	Band and Plate Clamp	-
FIT112	Tube Ladder Clamp	-
FIT113	Mullen Clamp	2
FIT201	DF Class B Right Angle Clamp UK	-
FIT202	DF Class B Swivel Clamp UK	-
FIT203	DF Class B Tube Sleeve Clamp UK	-
FIT204	DF Class B Int Spigot Joint UK	-
FPP101	Clamp ScaffoldPads	-
FPP102	Clamp Armadillos	-

# Tubes

Item Code	Description	Length	Weight
TWF104	Steel Tube w/Fitting 2'	2'0"	-
TWF111	Steel Tube w/Fitting 3'	3'0"	-
TWF116	Steel Tube w/Fitting 4'	4'0"	10
TWF120	Steel Tube w/Fitting 6'	6'0"	14
TWF124	Steel Tube w/Fitting 8'	8'0"	18
TWF126	Steel Tube w/Fitting 10'	10'0"	21
TWF129	Steel Tube w/Fitting 13'	13'0"	27
TWF132	Steel Tube w/ Fitting 16'	16'0"	33
TNF104	Steel Tube w/OUT Fitting 2'	2'0"	-
TNF111	Steel Tube w/OUT Fitting 3'	3'0"	3
TNF116	Steel Tube w/OUT Fitting 4'	4'0"	-
TNF118	Steel Tube w/OUT Fitting 5'	5'0"	-
TNF120	Steel Tube w/OUT Fitting 6'	6'0"	-
TNF124	Steel Tube w/OUT Fitting 8'	8'0"	-
TNF125	Steel Tube w/OUT Fitting 9'	9'0"	-
TNF126	Steel Tube w/OUT Fitting 10'	10'0"	-
TNF128	Steel Tube w/OUT Fitting 12'	12'0"	-
TNF129	Steel Tube w/OUT Fitting 13'	13'0"	-
TNF130	Steel Tube w/OUT Fitting 14'	14'0"	-
TNF132	Steel Tube w/OUT Fitting 16'	16'0"	-
TNF136	Steel Tube w/OUT Fitting 20'	20'0"	-
TAC101	Tube Baseplate Tredder	-	-
TWF201	Tubelock Baseplate	-	-
TFT101	External Tube Joiner	-	-
ANF132	Alum Tube w/OUT fitting 16'	-	17



Tubelock Base Plate



Steel Tube with fitting



# Accessories

Item Code	Description	Weight
RCK101	Scaffold Rack	106
RCK102	Scaffold Rack Long Leg	135
RCK103	Mesh Bin	175
RCK104	Scaffold Rack Solid Bin [Red]	
RCK105	Diamond Mesh Basket	150
ACS101	Hanging Leg Lock	8.5
ACS102	Pig Tail Pin	0.22
ACS103	Toggle Pin	-
ACS104	Mesh Insert for Scaffold Rack	68
ACS105	Davit Arm	24
ACS106	Gin Wheel	22.04
ACS107	Board Clips	-
TOL101	Scaffold Spanner 7/16"	-
TOL102	Self-Retracting Lifeline	-
CSB101	9 Gauge Wire Roll	50
WTF124	Wood Board 2'X4'X8'	10.5
WTF126	Wood Board 2'X4'X10'	
WTF128	Wood board 2'X4'X12'	



Davit Arm



Gin wheel



Wood board



Scaffold Rack



Mesh Bin



Hanging leg lock



Toggle pin



# Beams

Item Code	Description	Length	Weight
LBM122	7' Lattice Beam	7'0"	50.04
LBM124	8' Lattice Beam	8'0"	
LBM126	10' Lattice Beam	10'0"	66.5
LBM128	12' Lattice Beam	12'0"	90
LBM130	14' Lattice Beam	14'0"	98.1
LBM132	16' Lattice Beam	16'0"	-
LBM133	17' Lattice Beam	17'0"	
LBM136	20' Lattice Beam	20'0"	143.08
LBM137	21' Lattice Beam	21'0"	147.05
LBM144	28' Lattice Beam	28'0"	199.9
ALB129	Alum Lattice Beam 4.1m/13'5"	13'5"	37
ALB142	Alum Lattice Beam 8.1m/26'7"	26'7"	72
ALB136	Alum Lattice Beam 6.1m/20'	20'0"	54
JPN101	Alum Lattice Beam Joint Pin		5
SBM104	2.0M Steel Beam	2m	
SBM106	3.0M Steel Beam	3m	

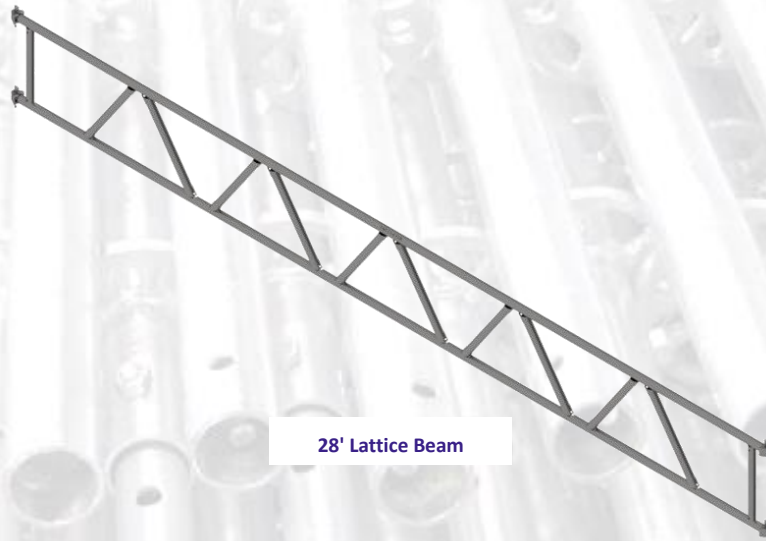

28' Lattice Beam

# Edge Protection

Item Code	Description	Weight
EPS101	Concrete Base Socket	3
EPS102	4 FT Post	15
EPS103	3 FT Extension Post	12
EPS104	Full Height Friction Post	-
EPS105	Full Height Compression Post	32
EPS106	4 FT Handrail	13
EPS107	8 FT Handrail	23
EPS108	8 x 4 FT Panel	-
EPS109	EP 8 x 3 FT Panel	28
EPS110	EP 8 FT Toe board	23
EPS111	EP 8 FT Full Height Panel	54
EPS112	EP 4 x 4 FT Panel	-
EPS113	EP 4 x 3 FT Panel	16
EPS114	EP 4 FT Toe board	12
EPS115	EP 4 FT Full Height Panel	30
EPS116	EP Primary Alum Beam Clamp	8
EPS117	EP Secondary Alum Beam Clamp	6
EPS118	EP Multi Slab Clamp	17
EPS126	EP Staircase Clamp	
EPS119	EP Exclusion Zone Post	23
EPS120	EP Slab Edge Bracket	-
EPS121	EP Steel I Beam Clamp	-
EPS122	EP Primary Timber Beam Clamp	16
EPS123	EP Secondary Timber Beam Clamp	-
EPS124	EP 6' Elevator Door Panel	-
EPS125	EP Gate	58

# Special Planks

Item Code	Description	Length
WLV116	LVL Scaffold Wood Plank 4'	4'0"
WLV120	LVL Scaffold Wood Plank 6'	6'0"
WLV124	LVL Scaffold Wood Plank 8'	8'0"
WLV126	LVL Scaffold Wood Plank 10'	10'0"
WLV132	LVL Scaffold Wood Plank 16'	16'0"
WFR116	Wood Plank 1.21m/4' - FR	4'0"
WFR118	Wood Plank 1.52m/5' - FR	5'0"
WFR120	Wood Plank 1.82m/6' - FR	6'0"
WFR124	Wood Plank 2.43m/8' - FR	8'0"
WFR126	Wood Plank 3.05m/10' - FR	10'0"
WFR128	Wood Plank 3.66m/12' - FR	12'0"
WFR129	Wood Plank 3.96m/13' - FR	13'0"
WSS116	OSHA Solid Sawn Wood Plank 4'	4'0"
WSS120	OSHA Solid Sawn Wood Plank 6'	6'0"
WSS124	OSHA Solid Sawn Wood Plank 8'	8'0"
WSS126	OSHA Solid Sawn Wood Plank 10'	10'0"
WDI116	DI-65 Scaffold Wood Plank 4'	4'0"
WDI120	DI-65 Scaffold Wood Plank 6'	6'0"
WDI124	DI-65 Scaffold Wood Plank 8'	8'0"
WDI126	DI-65 Scaffold Wood Plank 10'	10'0"
WDI128	DI-65 Scaffold Wood Plank 12'	12'0"
ALD126	10FT Alum Ladder Access deck	10'0"
ALD124	8FT Alum Ladder Access Deck	8'0"
APD122	19" X 7' Alum Plank Deck	7'0"
ASD136	20'x20" Alum Stage Deck	20'0"
ASD148	20'x32" Alum Stage Deck	20'0"
ASD336	20'x12" Alum Stage Deck	20'0"
ASD340	24'x24" Alum Stage Deck	24'0"
AWD115	19" X 3'10" Alum Ply Deck	3'10"
AWD119	19" X 5'2" Alum Ply Deck	5'2"
AWD122	19" X 7' Alum Ply Deck	7'0"
AWD124	19" X 8' Alum Ply Deck	8'0"
AWD126	19" X 10' Alum Ply Deck	10'0"



Aluminum ply deck



10' Aluminum ladder deck



Aluminum plank deck



DI-65 wood plank



# Infill Plank

Item Code	Description	Length	Weight
LIP101	LAY Infill Plank 0.30m/1'0"	1'0"	8
LIP102	LAY Infill Plank 0.38m/1'3"	1'3"	9
LIP103	LAY Infill Plank 0.58m/1'11"	1'11"	11
LIP104	LAY Infill Plank 0.61m/2'0"	2'0"	12
LIP105	LAY Infill Plank 0.66m/2'2"	2'2"	12
LIP106	LAY Infill Plank 0.74m/2'5"	2'5"	13
LIP107	LAY Infill Plank 0.76m/2'6"	2'6"	14
LIP108	LAY Infill Plank 0.83m/2'8-5/8"	2'8-5/8"	15
LIP109	LAY Infill Plank 0.84m/2'9"	2'9"	15
LIP111	LAY Infill Plank 0.91m/3'	3'0"	16
LIP112	LAY Infill Plank 1.067m/3'6"	3'6"	18
LIP113	LAY Infill Plank 1.083m/3'6-5/8"	3'6-5/8"	-
LIP114	LAY Infill Plank 1.09m/3'7"	3'7"	18
LIP115	LAY Infill Plank 1.17m/3'10"	3'10"	19
LIP116	LAY Infill Plank 1.22m/4'	4'0"	20
LIP117	LAY Infill Plank 1.40m/4'7"	4'7"	22
LIP118	LAY Infill Plank 1.52m/5'	5'0"	24
LIP119	LAY Infill Plank 1.57m/5'2"	5'2"	24
LIP120	LAY Infill Plank 1.83m/6'	6'0"	28
LIP121	LAY Infill Plank 2.07m/6'10"	6'10"	31
LIP122	LAY Infill Plank 2.13m/7'	7'0"	32
LIP123	LAY Infill Plank 2.39m/7'10"	7'10"	35
LIP124	LAY Infill Plank 2.44m/8'	8'0"	36
LIP125	LAY Infill Plank 2.57m/8'5"	8'5"	37
LIP126	LAY Infill Plank 3.05m/10'	10'0"	44
LIG119	Infill Plank Gap Filler 1.57m/5'2"	5'2"	-
LIG120	Infill Plank Gap Filler 1.83m/6'	6'0"	-
LIG122	Infill Plank Gap Filler 2.13m/7'	7'0"	-
LIG124	Infill Plank Gap Filler 2.44m/8'	8'0"	-
LIG126	Infill Plank Gap Filler 3.05m/10'	10'0"	-

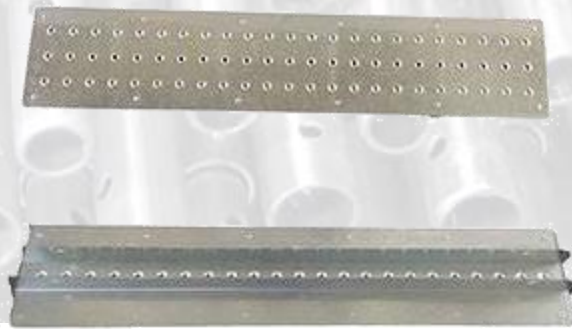

# Special Transoms

Item Code	Description	Length	Weight
MDT112	Mid Transom 1.067m/3'6"	3'6"	12
MDT113	Mid Transom 1.083m/3'6-5/8"	3'6'-5/8"	12
MDT114	Mid Transom 1.09m/3'7"	3'7"	12
MDT115	Mid Transom 1.17m/3'10"	3'10"	12
MDT116	Mid Transom 1.21m/4'	4'0"	13
MDT117	Mid Transom 1.40m/4'7"	4'7"	15
MDT118	Mid Transom 1.52m/5'	5'0"	15
MDT119	Mid Transom 1.57m/5'2"	5'2"	16
MDT120	Mid Transom 1.83m/6'	6'0"	18
MDT121	Mid Transom 2.07m/6'10"	6'10"	20
MDT122	Mid Transom 2.13m/7'	7'0"	20
MDT123	Mid Transom 2.40m/7'10"	7'10"	23
MDT124	Mid Transom 2.44m/8'	8'0"	23
MDT125	Mid Transom 2.57m/8'5"	8'5"	24
MDT126	Mid Transom 3.05m/10'	10'0"	28
PPT101	P to P Transom 240mm - 1 Board	240mm	8
PPT102	P to P Transom 480mm - 2 Board	480mm	10
PPT103	P to P Transom 720mm - 3 Board	720mm	12
LTP101	L to P Transom 240mm - 1 Board	240mm	-
LTP102	L to P Transom 480mm - 2 Board	480mm	-
LTP103	L to P Transom 720mm - 3 Board	720mm	-
LTP201	L to P Transom 320mm 1 Board	320mm	8.16
LTP202	L to P Transom 640mm-2 Board	640mm	10.76
LTP203	L to P Transom 960mm-3 Board	960mm	13.27
LDT101	Ladder Transom 2'9" - 1 Board	2'9"	15
LDT102	Ladder Transom 3'10" - 1 Board	3'10"	-
LDT103	Ladder Transom 4'7" - 2 Board	4'7"	-



# Ledger Gap Deck

Item Code	Description	Length	Weight
LGD101	Ledger Gap Deck 0.30m/1'0"	1'0"	6
LGD102	Ledger Gap Deck 0.38m/1'3"	1'3"	8
LGD103	Ledger Gap Deck 0.58m/1'11"	1'11"	11
LGD104	Ledger Gap Deck 0.61m/2'0"	2'0"	12
LGD105	Ledger Gap Deck 0.66m/2'2"	2'2"	12
LGD106	Ledger Gap Deck 0.74m/2'5"	2'5"	14
LGD107	Ledger Gap Deck 0.76m/2'6"	2'6"	14
LGD108	Ledger Gap Deck 0.83m/2'8-5/8"	2'8" - 5/8"	16
LGD109	Ledger Gap Deck 0.84m/2'9"	2'9"	17
LGD111	Ledger Gap Deck 0.91m/3'	3'0"	17
LGD112	Ledger Gap Deck 1.067m/3'6"	3'6"	20
LGD114	Ledger Gap Deck 1.09m/3'7"	3'7"	20
LGD115	Ledger Gap Deck 1.17m/3'10"	3'10"	21
LGD116	Ledger Gap Deck 1.22m/4'	4'0"	23
LGD117	Ledger Gap Deck 1.40m/4'7"	4'7"	26
LGD118	Ledger Gap Deck 1.52m/5'	5'0"	28
LGD119	Ledger Gap Deck 1.57m/5'2"	5'2"	29
LGD120	Ledger Gap Deck 1.83m/6'	6'0"	34
LGD121	Ledger Gap Deck 2.08m/6'10"	6'10"	39
LGD122	Ledger Gap Deck 2.13m/7'	7'0"	40
LGD123	Ledger Gap Deck 2.39m/7'10"	7'10"	45
LGD124	Ledger Gap Deck 2.44m/8'	8'0"	46
LGD125	Ledger Gap Deck 2.57m/8'5"	8'5"	48
LGD126	Ledger Gap Deck 3.05m/10'	10'0"	57





# Corner Planks

Item Code	Description	Weight
CNP103	Corner Plank 0.60m/1'11" $\Delta$	12.5
CNP108	Corner Plank 0.84m/ 2'8-5/8" $\Delta$	17.5
CNP112	Corner Plank 1.067m/3'6" $\Delta$	21
CNP117	Corner Plank 1.40m/4'7" $\Delta$	25

